





Ausgewähltes PVC Material

374	Winkel 90°, 45°	2 - 31	Schwimmbecken & Folien	
376	Bogen 90°, T-Stück 90°	242 - 283	Wasserattraktionen	
377	T-Stück 90°, 45°	32 - 75	Schwimmbadzubehör	
378	Kreuzstück, Übergangsmuffe	284 - 317	Wassererwärmung	
379	Reduktion kurz, lang	76 - 119	Einbauteile	
380	Verteilerrohr, Übergangsmuffe, Muffennippel	318 - 339	Abdeckungen	
381	Muffennippel, Verschraubung	120 - 145	Beleuchtung	
382	Verschraubung, Kappe	340 - 357	Reinigungszubehör	
383	Kappe, Stopfen, Schlauchtülle	146 - 165	Filteranlagen	
384	Bundbuchse, Flansch	358 - 371	Wasserpflege	
385	Flanschsatz, Schauglas, Kugelhahn	166 - 201	Filtertechnik	
386	Kugelhahn, 3-Wege Kugelhahn, Drehscheibenventil	372 - 401	PVC	
387	2- und 3-Wege Kugelhahn, elektrisch	202 - 221	Pumpen	
388	Manuelle und pneumatische Absperrklappe	402 - 419	Wettkampfausrüstung	
389	Elektrische Absperrklappe	222 - 241	Mess-, Regel- & Dosiertechnik	
390	Flanschsatz, Rückschlagklappe	420 - 449	Whirlpools	
391	Kegelfussventil, Kugelhahn mit Klemmverschraubung			
392	Winkel 90°, T-Stück 90°, Muffe - Klemmanschluss			
393	FlexFit-Schlauch Fittings			
395	Schlauch, Rohr PN10			
396	Rohr PN16, Rohrklemme			
397	PVC Kleber, Reiniger, Zubehör			
399	Ventilschächte			

PVC Druckfittings

PVC Winkel 90° mit Klebemuffen

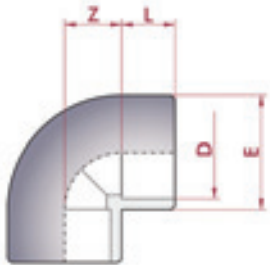

Artikel-Nr.	D	PN	L	Z	E	VPE	€ ohne MwSt.	€ inkl. MwSt.
11655 E	16	16	14	10	25	200 (20)	0,50	0,60
01712 E	20	16	16	11	27	140 (20)	0,50	0,60
01713 E	25	16	19	14	33	80 (10)	0,64	0,76
01714 E	32	16	22	17	41	90 (10)	0,97	1,15
01715 E	40	16	26	21	50	55	1,36	1,62
01716 E	50	16	31	26	61	60	2,00	2,38
01717 E	63	16	38	33	76	36	3,04	3,62
01718 E	75	16	44	39	90	21	5,64	6,71
01719 E	90	16	51	46	108	12	9,55	11,36
01720 E	110	16	61	56	131	14	17,77	21,15
• 01721 E	125	16	69	64	148	10	25,56	30,42
01722 E	140	16	76	71	164	5	43,75	52,06
01723 E	160	10	86	81	180	4	51,05	60,75
• 01724 E	200	10	106	101	225	3	80,04	95,25
01725 E	225	10	119	114	252	2	116,48	138,61
• 01726 E	250	10	131	126	284	2	279,27	332,33
• 01727 E	315	10	164	159	352	1	488,70	581,55

PVC Winkel 90° mit Klebemuffe und Innengewinde

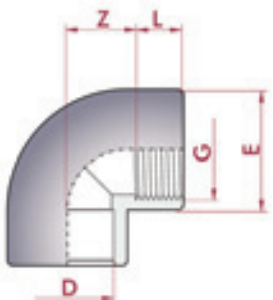

Artikel-Nr.	D x G	PN	L	Z	E	VPE	€ ohne MwSt.	€ inkl. MwSt.
• 01728 E	20 x 1/2"	10	16	11	28	130 (10)	1,05	1,25
• 01729 E	25 x 3/4"	10	19	14	34	70 (10)	1,23	1,46
• 01730 E	32 x 1"	10	22	17	43	30 (10)	1,64	1,95
• 01731 E	40 x 1 1/4"	10	26	21	54	50 (10)	2,15	2,56
• 01732 E	50 x 1 1/2"	10	31	26	63	28	3,18	3,78
• 01733 E	63 x 2"	10	38	33	78	16	4,48	5,33
• 22596 E	75 x 2 1/2"	10	44	40	89	9	13,86	16,49
• 22597 E	90 x 3"	10	51	48	106	6	20,79	24,74
• 22598 E	110 x 4"	10	61	58	129	3	32,01	38,09

PVC Winkel 90° mit Klebemuffe und Innengewinde, verstärkt durch VA-Ring

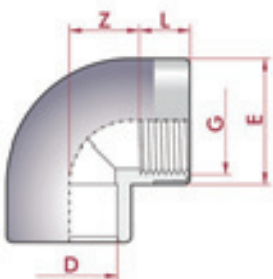

Artikel-Nr.	D x G	PN	L	Z	E	VPE	€ ohne MwSt.	€ inkl. MwSt.
• 01740 E	20 x 1/2"	16	16	11	28	130 (10)	2,12	2,52
• 01741 E	25 x 3/4"	16	19	14	34	70 (10)	2,48	2,95
• 01742 E	32 x 1"	16	22	17	43	30 (10)	3,19	3,80
• 01743 E	40 x 1 1/4"	16	26	21	54	20 (10)	4,08	4,86
• 01744 E	50 x 1 1/2"	16	31	26	63	28	5,83	6,94
• 01745 E	63 x 2"	16	38	33	78	16	7,71	9,17

i Fordern Sie unsere spezielle PVC/PP/PE Preisliste an. Darin finden Sie unser komplettes Programm an Druckfittingsn, Ventilen, Klappen etc..

PVC Druckfittings

PVC Winkel 90° mit Klebemuffe und Aussengewinde

Artikel-Nr.	D x G	PN	L1	L	E	Z	VPE	€ ohne MwSt.	€ inkl. MwSt.
02239 E	50 x 1½"	10	21	31	61	38	80	2,91	3,46
• 02240 E	63 x 2"	10	25	38	76	47	42	4,28	5,09

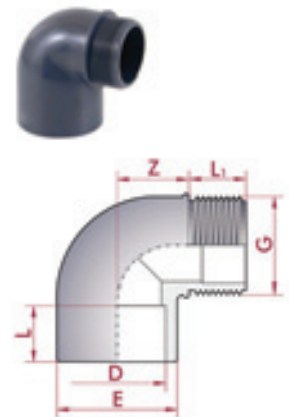

PVC Reduzierwinkel 90° mit Klebemuffe und Klebestutzen

Artikel-Nr.	D x D - d	PN	L	L1	E	VPE	€ ohne MwSt.	€ inkl. MwSt.
02237 E	50 x 50 - 40	16	31	26	61	70	2,52	3,00
02238 E	63 x 63 - 50	16	38	31	76	32	3,98	4,74

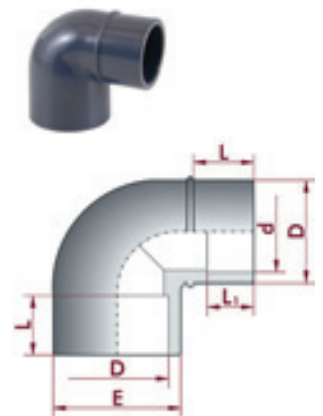

PVC Winkel 45° mit Klebemuffen

Artikel-Nr.	D	PN	L	Z	E	VPE	€ ohne MwSt.	€ inkl. MwSt.
• 16307 E	16	16	14	5	22	200 (20)	0,71	0,84
01746 E	20	16	16	5	28	140 (20)	0,71	0,84
01747 E	25	16	19	6	35	80 (10)	0,91	1,08
01748 E	32	16	22	8	43	100 (10)	1,23	1,46
01749 E	40	16	26	10	52	60	1,64	1,95
01750 E	50	16	31	12	61	40	2,20	2,62
01751 E	63	16	38	14	76	20	3,19	3,80
01752 E	75	16	44	17	93	25	6,30	7,50
01753 E	90	16	51	20	109	15	9,33	11,10
01754 E	110	16	61	24	133	16	15,75	18,74
• 01755 E	125	16	69	27	148	12	22,93	27,29
• 01756 E	140	16	76	30	164	8	36,94	43,96
• 01757 E	160	10	86	34	180	5	45,13	53,70
• 01758 E	200	10	106	43	225	4	66,87	79,58
• 01759 E	225	10	119	48	252	2	104,22	124,02

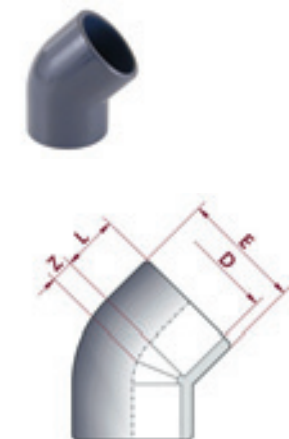

PVC Reduzierwinkel 45° mit Klebemuffe und Klebestutzen

Artikel-Nr.	D x D - d	PN	L	L1	E	VPE	€ ohne MwSt.	€ inkl. MwSt.
02241 E	50 x 50 - 40	16	31	26	61	90	3,33	3,96
02242 E	63 x 63 - 50	16	38	31	76	50	4,93	5,87

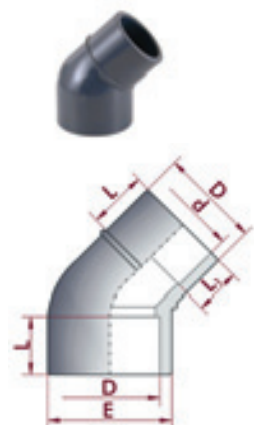

PVC Druckfittings

PVC Bogen 90° - kurz mit Klebemuffen

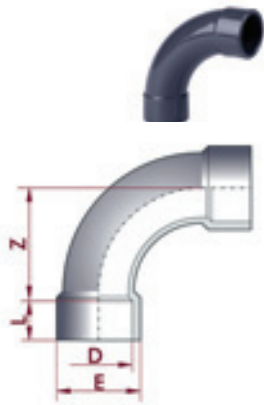

Artikel-Nr.	D	PN	L	Z	E	VPE	€ ohne MwSt.	€ inkl. MwSt.
• 01969 E	32	16	22	64	41	24	3,00	3,57
• 01970 E	40	16	26	80	50	25	3,94	4,69
• 01971 E	50	16	31	100	61	30	6,00	7,14
• 01972 E	63	16	38	126	76	15	9,66	11,50
• 01973 E	75	16	44	150	90	8	17,25	20,53
• 05331 E	90	16	51	180	113	4	38,40	45,70
• 05332 E	110	16	61	134	132	4	68,37	81,36
• 05333 E	125	10	69	186	150	5	135,52	161,27

PVC T-Stück 90° mit Klebemuffen

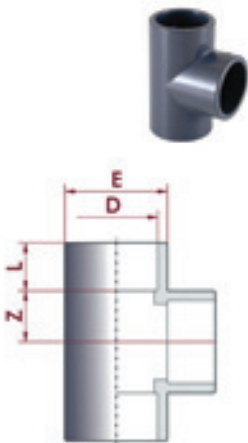

Artikel-Nr.	D	PN	L	Z	E	VPE	€ ohne MwSt.	€ inkl. MwSt.
• 16308 E	16	16	14	9	22	120 (20)	0,63	0,75
• 01780 E	20	16	16	11	27	100 (20)	0,63	0,75
• 01781 E	25	16	19	14	33	50 (10)	0,81	0,96
• 01782 E	32	16	22	17	41	60 (10)	1,18	1,40
• 01783 E	40	16	26	21	50	40	1,94	2,31
• 01784 E	50	16	31	26	63	48	2,75	3,27
• 01785 E	63	16	38	33	78	24	3,91	4,65
• 01786 E	75	16	44	39	90	15	8,24	9,81
• 01787 E	90	16	51	46	108	8	15,14	18,02
• 01788 E	110	16	6	56	131	10	22,12	26,32
• 01789 E	125	16	69	64	148	7	36,27	43,16
• 01790 E	140	16	76	71	164	4	55,11	65,58
• 01791 E	160	10	86	81	186	3	65,10	77,47
• 01792 E	200	10	106	101	228	2	104,32	124,14
• 01793 E	225	10	119	114	255	2	144,92	172,45

PVC T-Stück 90° reduziert mit Klebemuffen

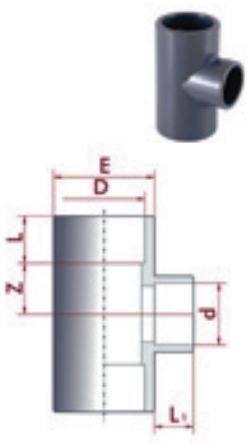

Artikel-Nr.	D x d	PN	L	L1	Z	E	VPE	€ ohne MwSt.	€ inkl. MwSt.
• 01814 E	25 x 20	16	19	16	14	33	50 (10)	1,03	1,23
• 01815 E	32 x 25	16	22	19	17	41	60 (10)	1,40	1,67
• 01816 E	32 x 20	16	22	16	17	41	60 (10)	1,40	1,67
• 01817 E	40 x 32	16	26	22	21	50	48	2,42	2,88
• 01818 E	40 x 25	16	26	19	21	50	48	2,42	2,88
• 01819 E	40 x 20	16	26	16	21	50	48	2,42	2,88
• 01820 E	50 x 40	16	31	26	26	61	48	3,15	3,75
• 01821 E	50 x 32	16	31	22	26	61	48	3,15	3,75
• 01822 E	50 x 25	16	31	19	26	61	54	3,15	3,75
• 01823 E	50 x 20	16	31	16	26	61	56	3,15	3,75
• 01824 E	63 x 50	16	38	31	33	76	27	5,24	6,24
• 01825 E	63 x 40	16	38	26	33	76	28	5,24	6,24
• 01826 E	63 x 32	16	38	22	33	76	30	5,24	6,24
• 01827 E	63 x 25	16	38	19	33	76	30	5,24	6,24
• 01828 E	63 x 20	16	38	16	33	76	30	5,24	6,24
• 01829 E	75 x 63	16	44	38	39	90	16	8,89	10,58
• 01830 E	75 x 50	16	44	31	39	90	18	8,89	10,58
• 01831 E	75 x 40	16	44	26	39	90	18	8,89	10,58
• 01832 E	75 x 32	16	44	22	39	90	18	8,89	10,58
• 01833 E	90 x 75	16	51	44	46	108	9	15,73	18,72
• 01834 E	90 x 63	16	51	38	46	108	9	15,73	18,72
• 01835 E	90 x 50	16	51	31	46	108	9	15,73	18,72
• 01836 E	90 x 40	16	51	26	46	108	9	15,73	18,72
• 01837 E	110 x 90	16	61	51	56	131	11	22,52	26,80

PVC Druckfittings

PVC T-Stück 45° mit Klebemuffen

Artikel-Nr.	D	PN	L	Z	Z1	E	VPE	€ ohne MwSt.	€ inkl. MwSt.
• 22583 E	20	16	16	7	29	28	70 (10)	3,04	3,62
• 22584 E	25	16	19	7	36	34	40 (10)	3,51	4,18
• 22585 E	32	16	22	8	44	42	24	3,92	4,66
• 22586 E	40	16	26	10	54	51	30	5,37	6,39
• 20155 E	50	10	31	13	67	61	32	5,61	6,68
• 20156 E	63	10	38	15	83	76	18	8,02	9,54
• 32804 E	75	10	44	18	101	91	11	30,94	36,82
• 32805 E	90	10	51	20	122	106	6	50,86	60,53
• 32806 E	110	10	61	27	149	133	7	103,02	122,59

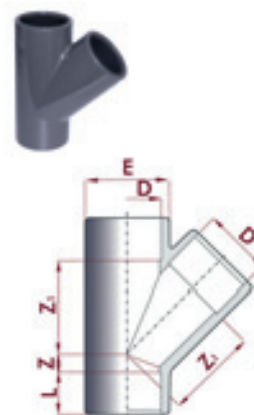

PVC T-Stück mit Klebemuffen und Innengewinde

Artikel-Nr.	D x G	PN	L	Z	E	VPE	€ ohne MwSt.	€ inkl. MwSt.
• 01796 E	20 x 1/2"	10	16	11	28	100 (10)	1,34	1,59
• 01797 E	25 x 3/4"	10	19	14	34	50 (10)	1,51	1,80
• 01798 E	32 x 1"	10	22	17	43	30 (10)	1,91	2,27
• 01799 E	40 x 1 1/4"	10	26	21	54	19	3,13	3,72
• 01800 E	50 x 1 1/2"	10	31	26	63	21	4,28	5,09
• 01801 E	63 x 2"	10	38	33	78	12	6,95	8,27
• 22602 E	75 x 2 1/2"	10	44	39	89	6	15,99	19,03
• 22603 E	90 x 3"	10	51	47	106	3	23,95	28,50
• 22604 E	110 x 4"	10	61	57	129	2	39,47	46,97



PVC T-Stück 90° mit Klebemuffen und Innengewinde, verstärkt

Artikel-Nr.	D x G	PN	L	Z	E	VPE	€ ohne MwSt.	€ inkl. MwSt.
• 01808 E	20 x 1/2"	16	16	11	28	100 (10)	2,42	2,88
• 01809 E	25 x 3/4"	16	19	14	34	50 (10)	2,79	3,32
• 01810 E	32 x 1"	16	22	17	43	30 (10)	3,48	4,14
• 01811 E	40 x 1 1/4"	16	26	21	54	19	5,00	5,95
• 01812 E	50 x 1 1/2"	16	31	26	63	21	6,92	8,23
• 01813 E	63 x 2"	16	38	33	78	12	10,17	12,10

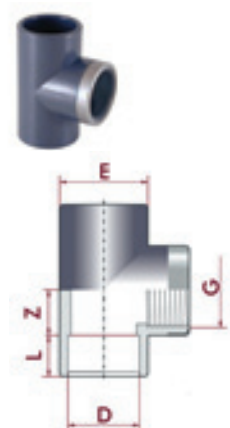

i Fordern Sie unsere spezielle PVC/PP/PE Preisliste an. Darin finden Sie unser komplettes Programm an Druckfittingsn, Ventilen, Klappen etc..

PVC Druckfittings

PVC T-Stück 90° mit Klebemuffen und Innengewinde, reduziert

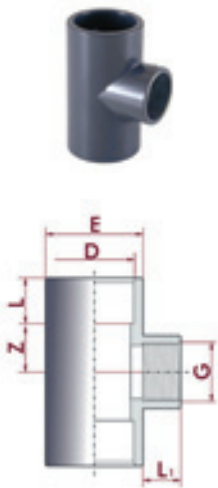

Artikel-Nr.	D x G	PN	L	L1	Z	E	VPE	€ ohne MwSt.	€ inkl. MwSt.
• 01849 E	25 x 1/2"	10	19	14	14	33	50 (10)	1,52	1,81
• 01850 E	32 x 3/4"	10	22	16	17	41	30 (10)	1,95	2,32
• 01851 E	32 x 1/2"	10	22	14	17	41	30 (10)	1,95	2,32
• 01852 E	40 x 1"	10	26	19	21	50	40 (10)	2,96	3,52
• 01853 E	40 x 3/4"	10	26	16	21	50	40 (10)	2,96	3,52
• 01854 E	40 x 1/2"	10	26	14	21	50	40 (10)	2,96	3,52
• 01855 E	50 x 1 1/4"	10	31	20	26	61	24	4,44	5,28
• 01856 E	50 x 1"	10	31	19	26	61	24	4,44	5,28
• 01857 E	50 x 3/4"	10	31	16	26	61	24	4,44	5,28
• 01858 E	50 x 1/2"	10	31	14	26	61	24	4,44	5,28
• 01859 E	63 x 1 1/2"	10	38	20	33	76	13	6,93	8,25
• 01860 E	63 x 1 1/4"	10	38	20	33	76	14	6,93	8,25
• 01861 E	63 x 1"	10	38	19	33	76	15	6,93	8,25
• 01862 E	63 x 3/4"	10	38	16	33	76	15	6,93	8,25
• 01863 E	63 x 1/2"	10	38	14	33	76	15	6,93	8,25

PVC Kreuzstück mit Klebemuffen

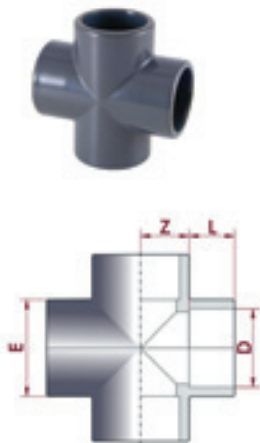

Artikel-Nr.	D	PN	L	Z	E	VPE	€ ohne MwSt.	€ inkl. MwSt.
• 20143 E	20	16	16	11	29	60 (10)	1,37	1,63
• 20144 E	25	16	19	14	35	40 (10)	1,72	2,05
• 20145 E	32	16	22	17	43	20 (10)	2,48	2,95
• 20146 E	40	16	26	21	52	30	4,08	4,86
• 02235 E	50	16	31	26	63	32	5,50	6,55
• 02236 E	63	16	38	33	79	16	7,79	9,27
• 27958 E	75	16	42	39	92	12	31,87	37,92
• 22581 E	90	16	51	46	106	12	40,83	48,59
• 22582 E	110	16	61	56	130	6	64,97	77,32

PVC Übergangsmuffe

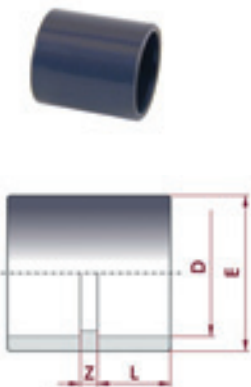

Artikel-Nr.	D	PN	L	Z	E	VPE	€ ohne MwSt.	€ inkl. MwSt.
• 16309 E	16	16	14	3	22	200 (20)	0,60	0,71
• 01872 E	20	16	16	3	27	200 (20)	0,59	0,70
• 01873 E	25	16	19	3	33	120 (20)	0,71	0,84
• 01874 E	32	16	22	3	41	160 (20)	0,81	0,96
• 01875 E	40	16	26	3	50	80 (10)	1,24	1,48
• 01876 E	50	16	31	3	61	60	1,58	1,88
• 01877 E	63	16	38	3	75	35	2,33	2,77
• 01878 E	75	16	44	4	90	14	4,79	5,70
• 01879 E	90	16	51	5	108	18	6,20	7,38
• 01880 E	110	16	61	6	129	12	10,26	12,21
• 01881 E	125	16	69	7	148	16	15,75	18,74
• 01882 E	140	16	76	9	164	12	23,33	27,76
• 01883 E	160	10	86	9	180	3	31,58	37,58
• 01884 E	200	10	106	10	225	3	47,23	56,20
• 01885 E	225	10	119	10	252	4	77,11	91,76

PVC Druckfittings

PVC Reduktion, kurz

Artikel-Nr.	D x d	PN	L	L1	Z	Mod.	VPE	€	
								ohne MwSt.	inkl. MwSt.
01914 E	20 x 16	16	16	14	2	A	200 (20)	0,38	0,45
01915 E	25 x 20	16	19	16	3	A	200 (20)	0,43	0,51
01916 E	32 x 25	16	22	19	3	A	200 (20)	0,46	0,55
01917 E	32 x 20	16	22	16	6	A	200 (20)	0,63	0,75
01918 E	40 x 32	16	26	22	4	A	120 (20)	0,72	0,86
• 01919 E	40 x 25	16	26	19	7	A	120 (10)	0,93	1,11
• 01920 E	40 x 20	16	26	16	10	B	120 (10)	0,93	1,11
• 01921 E	50 x 40	16	31	26	5	A	60 (20)	0,88	1,05
• 01922 E	50 x 32	16	31	22	9	B	60 (10)	1,26	1,50
• 01923 E	50 x 25	16	31	19	12	B	60 (10)	1,27	1,51
• 01924 E	50 x 20	16	31	16	15	B	60 (10)	1,27	1,51
01925 E	63 x 50	16	38	31	7	A	48	1,19	1,42
01926 E	63 x 40	16	38	26	12	B	40 (10)	1,67	1,99
01927 E	63 x 32	16	38	22	16	B	40 (10)	1,67	1,99
01928 E	75 x 63	16	44	38	6	A	28	2,11	2,51
18685 E	75 x 50	16	44	31	13	B	28	2,48	2,95
• 18686 E	75 x 40	16	44	26	18	B	28	2,48	2,95
01929 E	90 x 75	16	51	44	7	A	28	3,45	4,11
18687 E	90 x 63	16	51	38	13	B	36	3,99	4,75
• 18688 E	90 x 50	16	51	31	20	B	36	3,99	4,75
01930 E	110 x 90	16	61	51	10	A	16	6,66	7,93
• 18689 E	110 x 75	16	61	44	17	B	16	7,57	9,01
• 18690 E	110 x 63	16	61	38	23	B	16	7,66	9,12
• 01931 E	125 x 110	16	69	61	8	A	24	8,68	10,33
• 18691 E	125 x 90	16	69	51	18	B	12	10,06	11,97
• 20142 E	125 x 75	16	69	44	25	B	12	10,25	12,20
• 01932 E	140 x 125	16	76	69	8	A	20	11,77	14,01
• 18692 E	140 x 110	16	76	61	15	B	10	13,23	15,74
• 01933 E	160 x 140	10	86	76	10	A	12	15,41	18,34
• 18693 E	160 x 110	10	86	61	25	B	6	17,44	20,75
• 01934 E	200 x 180	10	106	96	10	A	6	29,90	35,58
• 01935 E	200 x 160	10	106	86	20	B	6	29,82	35,49



PVC Reduktion, lang

Artikel-Nr.	D-E x d	PN	L	L1	Z	F	VPE	€	
								ohne MwSt.	inkl. MwSt.
• 01974 E	32-25 x 25	16	22	19	30	33	100 (10)	0,77	0,92
• 01975 E	32-25 x 20	16	22	16	30	27	120 (10)	0,77	0,92
• 01976 E	40-32 x 32	16	26	22	36	38	50 (10)	0,99	1,18
• 01977 E	40-32 x 25	16	26	19	36	33	60 (10)	0,99	1,18
• 01978 E	40-32 x 20	16	26	16	36	27	80 (10)	0,99	1,18
• 01979 E	50-40 x 40	16	31	26	44	48	30 (10)	1,42	1,69
• 01980 E	50-40 x 32	16	31	22	44	41	60 (10)	1,42	1,69
• 01981 E	50-40 x 25	16	31	19	44	33	40 (10)	1,42	1,69
• 01982 E	50-40 x 20	16	31	16	44	27	50 (10)	1,42	1,69
• 01983 E	63-50 x 50	16	38	31	54	61	20	2,27	2,70
• 01984 E	63-50 x 40	16	38	26	54	50	46	2,27	2,70
• 01985 E	63-50 x 32	16	38	22	54	41	30	2,27	2,70
• 01986 E	63-50 x 25	16	38	19	54	33	30	2,27	2,70
• 01987 E	63-50 x 20	16	38	16	54	27	30	2,27	2,70
• 01988 E	75-63 x 63	16	44	38	62	73	26	3,64	4,33
• 01989 E	75-63 x 50	16	44	31	62	61	40	3,64	4,33
• 01990 E	75-63 x 40	16	44	26	62	50	40	3,64	4,33
• 01991 E	75-63 x 32	16	44	22	62	41	40	3,64	4,33
• 01992 E	90-75 x 75	16	51	44	74	87	12	4,74	5,64
• 01993 E	90-75 x 63	16	51	38	74	75	34	4,74	5,64
• 01994 E	90-75 x 50	16	51	31	74	61	48	4,74	5,64
• 01995 E	90-75 x 40	16	51	26	74	50	24	4,74	5,64
• 01996 E	110-90 x 90	16	61	51	88	105	16	8,66	10,31
• 01997 E	110-90 x 75	16	61	44	88	90	18	8,66	10,31
• 01998 E	110-90 x 63	16	61	38	88	75	27	8,66	10,31
• 01999 E	110-90 x 50	16	61	31	88	61	27	8,66	10,31

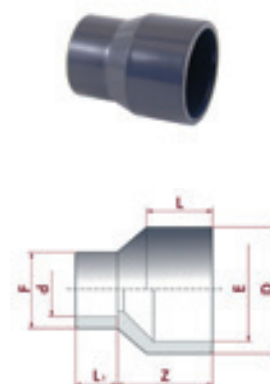

PVC Druckfittings



PVC Verteilerrohr mit Klebemuffen

Artikel-Nr.		VPE	€ ohne MwSt.	€ inkl. MwSt.
• 31877 E	Ø 50 mm	1	13,70	16,30
• 34407 E	Ø 63 mm	1	24,15	28,74



PVC Übergangsmuffe mit Klebemuffe und Innengewinde

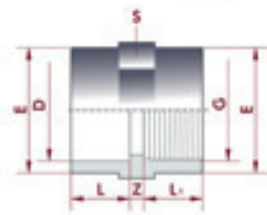

Artikel-Nr.	D x G	PN	L	L1	Z	E	S	VPE	€ ohne MwSt.	€ inkl. MwSt.
• 01888 E	16 x 3/8"	10	14	14	3	22	22	200 (20)	1,06	1,26
• 01889 E	20 x 1/2"	10	16	14	3	28	27	180 (20)	1,06	1,26
• 01890 E	25 x 3/4"	10	19	16	3	34	33	100 (20)	1,23	1,46
• 01891 E	32 x 1"	10	22	19	3	43	41	120 (20)	1,35	1,61
• 01892 E	40 x 1 1/4"	10	26	20	3	54	50	60 (10)	1,78	2,12
• 01893 E	50 x 1 1/2"	10	31	20	3	63	61	56	2,31	2,75
• 01894 E	63 x 2"	10	38	24	3	78	75	28	3,28	3,90
• 01895 E	75 x 2 1/2"	10	44	44	4	90	90	14	7,14	8,50
• 01896 E	90 x 3"	10	51	51	6	108	108	24	10,79	12,84
• 01897 E	110 x 4"	10	61	61	6	135	135	24	17,18	20,44



PVC Übergangsmuffe mit Klebemuffe und Innengewinde, verstärkt

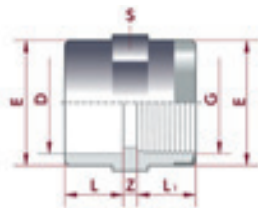

Artikel-Nr.	D x G	PN	L	L1	Z	E	S	VPE	€ ohne MwSt.	€ inkl. MwSt.
• 01908 E	20 x 1/2"	16	16	14	3	28	27	180 (20)	2,18	2,59
• 01909 E	25 x 3/4"	16	19	16	3	34	33	100 (10)	2,48	2,95
• 01910 E	32 x 1"	16	22	19	3	43	41	60 (10)	2,89	3,44
• 01911 E	40 x 1 1/4"	16	26	20	3	54	50	56	3,69	4,39
• 01912 E	50 x 1 1/2"	16	31	20	3	63	61	56	4,80	5,71
• 01913 E	63 x 2"	16	38	24	3	78	75	28	6,38	7,59



PVC Übergangsmuffennippel, mit Klebemuffe und Aussengewinde

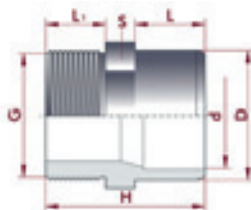

Artikel-Nr.	D - d x G	PN	L	L1	H	S	VPE	€ ohne MwSt.	€ inkl. MwSt.
• 02073 E	16 - 12 x 3/8"	10	14	11	35	24	200 (20)	0,61	0,73
• 02074 E	20 - 16 x 1/2"	10	16	14	42	27	200 (20)	0,69	0,82
• 02075 E	20 - 16 x 3/8"	10	16	11	39	27	200 (20)	0,69	0,82
• 02076 E	25 - 20 x 3/4"	10	19	16	47	32	120 (20)	0,80	0,95
• 02077 E	25 - 20 x 1/2"	10	19	14	45	32	140 (20)	0,80	0,95
• 02078 E	25 - 20 x 3/8"	10	19	11	42	32	140 (20)	0,80	0,95
• 02079 E	32 - 25 x 1"	10	22	19	54	36	80 (20)	0,91	1,08
• 02080 E	32 - 25 x 3/4"	10	22	16	51	36	80 (20)	0,91	1,08
• 02081 E	32 - 25 x 1/2"	10	22	14	49	36	80 (20)	0,91	1,08
• 02082 E	40 - 32 x 1 1/4"	10	26	21	60	46	50 (10)	1,24	1,48
• 02083 E	40 - 32 x 1"	10	26	19	58	46	50 (10)	1,24	1,48
• 02084 E	40 - 32 x 3/4"	10	26	16	55	46	50 (10)	1,24	1,48
• 02085 E	50 - 40 x 1 1/2"	10	31	25	70	55	24	1,56	1,86
• 02086 E	50 - 40 x 1 1/4"	10	31	21	66	55	68	1,58	1,88
• 02087 E	50 - 40 x 1"	10	31	19	64	55	70 (10)	1,58	1,88
• 02088 E	63 - 50 x 2"	10	38	25	78	65	46	2,53	3,01
• 02089 E	63 - 50 x 1 1/2"	10	38	21	73	65	60	2,59	3,08
• 02090 E	63 - 50 x 1 1/4"	10	38	21	73	65	60	2,59	3,08
• 02091 E	75 - 63 x 2 1/2"	10	44	30	89	78	24	4,11	4,89
• 02092 E	75 - 63 x 2"	10	44	25	84	78	30	4,11	4,89
• 02093 E	75 - 63 x 1 1/2"	10	44	21	80	78	30	4,11	4,89

PVC Druckfittings

PVC Übergangs-Muffennippel, mit Klebemuffe und Innengewinde

Artikel-Nr.	D x G	PN	L	L1	L2	H	S	VPE	€	
									ohne MwSt.	inkl. MwSt.
• 02243 E	20 - 16 x 3/4"	10	19	16	14	44	32	120 (20)	1,14	1,36
02244 E	20 - 16 x 1/2"	10	18	16	14	43	32	140 (20)	1,14	1,36
02245 E	20 - 16 x 3/8"	10	14	16	14	39	32	160 (20)	1,14	1,36
02246 E	20 - 16 x 1/4"	10	12	16	14	37	32	200 (20)	1,14	1,36
• 02247 E	25 - 20 x 1"	10	22	19	16	50	36	60 (10)	1,46	1,74
• 02248 E	25 - 20 x 3/4"	10	19	19	16	47	32	100 (10)	1,34	1,59
02249 E	25 - 20 x 1/2"	10	18	19	16	46	32	120 (10)	1,34	1,59
• 02250 E	32 - 25 x 1 1/4"	10	25	22	19	56	46	30 (10)	1,94	2,31
• 02251 E	32 - 25 x 1"	10	22	22	19	53	36	60 (10)	1,79	2,13
02252 E	32 - 25 x 3/4"	10	19	22	19	50	36	80 (10)	1,79	2,13
• 24822 E	32 - 25 x 1/2"	10	18	22	19	49	36	80 (10)	1,79	2,13
• 02253 E	40 - 32 x 1 1/2"	10	25	26	22	60	55	30 (10)	2,70	3,21
• 02254 E	40 - 32 x 1 1/4"	10	25	26	22	60	46	50 (10)	2,31	2,75
• 02255 E	40 - 32 x 1"	10	22	26	22	57	46	50 (10)	2,31	2,75
• 02256 E	50 - 40 x 2"	10	29	31	26	69	65	45	4,05	4,82
• 02257 E	50 - 40 x 1 1/2"	10	25	31	26	65	55	40 (10)	3,27	3,89
• 02258 E	50 - 40 x 1 1/4"	10	25	31	26	65	55	40 (10)	3,27	3,89
• 02259 E	63 - 50 x 2 1/2"	10	34	38	31	81	78	24	6,51	7,75
02260 E	63 - 50 x 2"	10	29	38	31	76	65	36	4,91	5,84
• 02261 E	63 - 50 x 1 1/2"	10	25	38	31	72	65	36	4,91	5,84
• 02262 E	75 - 63 x 3"	10	37	44	38	96	108	16	9,48	11,28
• 02263 E	75 - 63 x 2 1/2"	10	34	44	38	87	78	12	6,87	8,18
• 02264 E	75 - 63 x 2"	10	29	44	38	82	78	24	6,87	8,18

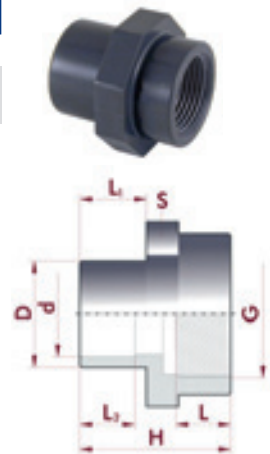

PVC Doppelnippel mit Aussengewinde

Artikel-Nr.	G	PN	L	H	S	VPE	€	
							ohne MwSt.	inkl. MwSt.
• 02111 E	3/8"	10	11	32	20	200 (20)	0,80	0,95
• 02112 E	1/2"	10	14	40	27	200 (20)	0,85	1,01
• 02113 E	3/4"	10	16	44	32	120 (20)	1,02	1,21
• 02114 E	1"	10	19	51	36	80 (20)	1,23	1,46
• 02115 E	1 1/4"	10	21	55	46	50 (10)	1,51	1,80
• 02116 E	1 1/2"	10	21	56	55	36	1,99	2,37
• 02117 E	2"	10	26	66	65	46	2,53	3,01

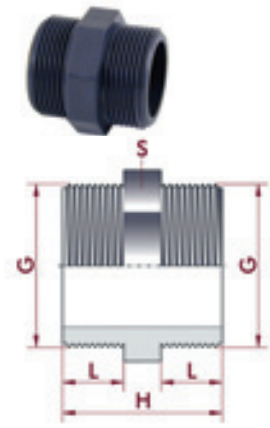

PVC Verschraubung, 3-teilig mit Klebemuffen

Artikel-Nr.	D	PN	L	Z	G	E	O-Ring	VPE	€	
									ohne MwSt.	inkl. MwSt.
• 20157 E	16	16	14	13	3/4"	34	15,5 x 2,6	100 (10)	1,96	2,33
02327 E	20	16	16	13	1"	41	20,2 x 3,5	80 (10)	1,94	2,31
02328 E	25	16	19	13	1 1/4"	52	28,2 x 3,5	40 (10)	2,24	2,67
02329 E	32	16	22	13	1 1/2"	60	32,9 x 3,5	30	3,15	3,75
02330 E	40	16	26	15	2"	74	40,6 x 5,3	40	3,78	4,50
02331 E	50	16	31	17	2 1/4"	80	47,0 x 5,3	30	4,64	5,52
02332 E	63	16	38	21	2 3/4"	99	59,7 x 5,3	12	6,76	8,04
02333 E	75	10	44	21	3 1/2"	120	75,6 x 5,3	16	19,64	23,37
02334 E	90	10	51	24	4"	138	91,4 x 5,3	12	25,98	30,92
02335 E	110	10	61	26	5 1/2"	179	110,5x5,3	5	37,98	45,20



PVC Druckfittings

PVC Übergangs-Verschraubung mit Klebemuffe und Innengewinde



Artikel-Nr.	D x G	PN	L	Z	G1	E	O-Ring	VPE	€ ohne MwSt.	€ inkl. MwSt.
• 20158 E	16 x 3/8"	16	14	13	3/4"	34	15,5 x 2,6	100 (10)	2,22	2,64
• 02336 E	20 x 1/2"	16	16	13	1"	41	20,2 x 3,5	80 (10)	2,26	2,69
• 02337 E	25 x 3/4"	16	19	13	1 1/4"	52	28,2 x 3,5	40 (10)	2,65	3,15
• 02338 E	32 x 1"	16	22	13	1 1/2"	60	32,9 x 3,5	30	3,55	4,22
• 02339 E	40 x 1 1/4"	16	26	15	2"	74	40,6 x 5,3	40	4,46	5,31
• 02340 E	50 x 1 1/2"	16	31	17	2 1/4"	80	47,0 x 5,3	30	5,36	6,38
• 02341 E	63 x 2"	16	38	21	2 3/4"	99	59,7 x 5,3	12	7,78	9,26
• 02342 E	75 x 2 1/2"	10	44	21	3 1/2"	120	75,6 x 5,3	16	21,79	25,93
• 02343 E	90 x 3"	10	51	24	4"	138	91,4 x 5,3	12	27,81	33,09
• 02344 E	110 x 4"	10	61	26	5 1/2"	179	110,5x5,3	5	44,20	52,60

PVC Verschraubung mit Klebemuffe und Aussengewinde und O-Ring



Artikel-Nr.	D x G	PN	L1	L	Z	VPE	€ ohne MwSt.	€ inkl. MwSt.
• 07716 E	50 x 1 1/2"	10	31	21	49	30	6,06	7,21
• 26638 E	50 x 2"	10	31	28	46	12	8,52	10,14
• 07717 E	63 x 2"	10	38	28	51	12	9,36	11,14

PVC Verschraubung mit Klebemuffe und Aussengewinde



Artikel-Nr.	D x G	PN	L1	L	Z	VPE	€ ohne MwSt.	€ inkl. MwSt.
• 02357 E	50 x 1 1/2"	16	31	21	48	30	4,80	5,71
• 02358 E	63 x 2"	16	38	28	62	12	7,76	9,23

PVC Kappe mit Klebemuffe

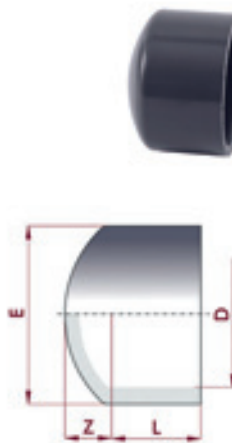

Artikel-Nr.	D	PN	L	Z	E	VPE	€ ohne MwSt.	€ inkl. MwSt.
• 01942 E	16	16	14	7	22	200 (20)	0,42	0,50
• 01943 E	20	16	16	8	25	200 (20)	0,45	0,54
• 01944 E	25	16	19	9	32	200 (20)	0,54	0,64
• 01945 E	32	16	22	10	40	120 (20)	0,73	0,87
• 01946 E	40	16	26	12	50	70 (10)	1,13	1,34
• 01947 E	50	16	31	15	63	48	1,64	1,95
• 01948 E	63	16	38	17	75	24	2,27	2,70
• 01949 E	75	16	44	19	90	32	4,31	5,13
• 01950 E	90	16	51	23	110	16	7,01	8,34
• 01951 E	110	16	61	28	131	9	14,18	16,87

PVC Druckfittings

PVC Kappe mit Innengewinde

Artikel-Nr.	G	PN	L	E	H	S	VPE	€	
								ohne MwSt.	inkl. MwSt.
• 01957 E	3/8"	10	14	24	20	24	200 (20)	0,96	1,14
• 01958 E	1/2"	10	14	27	23	27	200 (20)	1,02	1,21
• 01959 E	3/4"	10	14	33	28	33	160 (20)	1,11	1,32
• 01960 E	1"	10	16	41	33	41	80 (10)	1,37	1,63
• 01961 E	1 1/4"	10	19	50	36	50	50 (10)	1,91	2,27
• 01962 E	1 1/2"	10	20	61	43	61	40	2,49	2,96
• 01963 E	2"	10	20	75	50	75	22	3,33	3,96



PVC Stopfen mit Aussengewinde

Artikel-Nr.	G	PN	L	H	S	VPE	€	
							ohne MwSt.	inkl. MwSt.
• 02121 E	1/4"	10	10	18	12	200 (20)	0,57	0,68
• 02122 E	3/8"	10	10	22	20	200 (20)	0,61	0,73
• 02123 E	1/2"	10	14	27	27	200 (20)	0,72	0,86
• 02124 E	3/4"	10	16	30	32	200 (20)	0,87	1,04
• 02125 E	1"	10	19	34	36	120 (20)	1,24	1,48
• 02126 E	1 1/4"	10	21	36	46	80 (10)	1,64	1,95
• 02127 E	1 1/2"	10	21	37	55	60	2,13	2,53
• 02128 E	2"	10	26	42	65	70	2,49	2,96

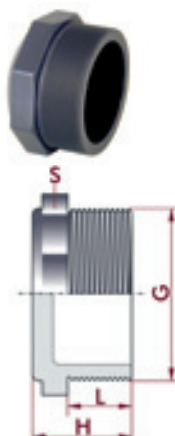

PVC Druck-Schlauchtülle mit Klebestutzen

Artikel-Nr.	D x E	PN	H	L1	L	E	VPE	€	
								ohne MwSt.	inkl. MwSt.
• 02200 E	16 x 16	10	49	14	35	16	200 (20)	0,63	0,75
• 02201 E	20 x 18	10	51	16	35	18	200 (20)	0,73	0,87
• 02202 E	20 x 20	10	54	16	38	20	200 (20)	0,76	0,90
• 02203 E	25 x 25	10	61	19	42	25	120 (20)	0,96	1,14
• 02204 E	32 x 30	10	69	22	47	30	80 (20)	1,22	1,45
• 02205 E	40 x 40	10	78	26	52	40	40 (10)	1,43	1,70
• 02206 E	50 x 50	10	88	31	57	50	30	2,02	2,40
• 02207 E	50 x 38	10	88	31	57	38	40	2,06	2,45
• 02208 E	63 x 60	10	98	38	60	61	18	2,55	3,03



PVC Druck-Schlauchtülle mit Aussengewinde

Artikel-Nr.	G x E	PN	H	L1	S	L	E	VPE	€	
									ohne MwSt.	inkl. MwSt.
• 02217 E	3/8" x 16	10	54	11	35	18	16	200 (20)	0,61	0,72
• 02218 E	1/2" x 18	10	58	15	35	22	18	200 (20)	0,72	0,86
• 02219 E	1/2" x 20	10	60	15	38	22	20	180 (20)	0,76	0,90
• 02220 E	3/4" x 25	10	67	17	42	27	25	120 (20)	0,94	1,12
• 15763 E	3/4" x 20	10	62	17	36	27	20	140 (20)	0,97	1,15
• 02221 E	1" x 30	10	78	21	47	36	30	60 (20)	1,22	1,45
• 09031 E	1" x 25	10	78	21	47	36	25	80 (20)	1,22	1,45
• 02222 E	1 1/4" x 40	10	84	22	52	46	40	30 (10)	1,44	1,71
• 02223 E	1 1/2" x 50	10	89	22	57	50	50	30	2,06	2,45
• 02224 E	1 1/2" x 38	10	89	22	57	50	38	36	2,02	2,40
• 09032 E	1 1/2" x 40	10	89	22	57	50	40	36	2,09	2,49
• 02225 E	2" x 60	10	100	26	60	65	61	15	2,60	3,09



PVC Druckfittings

PVC Bundbuchse glatt mit Klebemuffe



Artikel-Nr.	D	PN	L	Z	B	E	F	VPE	€ ohne MwSt.	€ inkl. MwSt.
• 02020 E	50	16	31	3	8	61	73	40	2,27	2,70
02021 E	63	16	38	3	9	76	90	18	2,78	3,31
02022 E	75	16	44	3	10	90	106	29	3,82	4,55
02023 E	90	16	51	5	11	108	125	14	5,75	6,84
02024 E	110	16	61	5	12	131	150	20	7,22	8,59
• 02025 E	125	16	69	5	13	148	168	14	9,50	11,31
02026 E	140	16	76	5	14	165	188	10	12,68	15,09
02027 E	160	10	86	5	16	188	213	12	17,53	20,86
• 02028 E	200	10	106	6	20	225	247	7	32,05	38,14
• 02029 E	225	10	119	6	25	248	274	6	38,13	45,37
• 02030 E	250	10	131	8	27	282	328	5	85,59	101,85

Losflansch

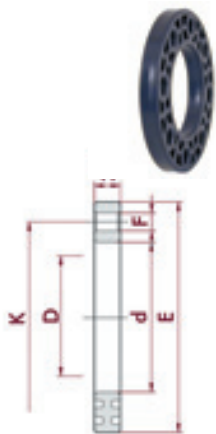

Artikel-Nr.	D	PN	d	E	H	K	F	VPE	€ ohne MwSt.	€ inkl. MwSt.
• 02032 E	50	16	62	150	17	110	18 x 4	18	4,78	5,69
02033 E	63	16	78	165	18	125	18 x 4	20	5,26	6,26
02034 E	75	16	92	185	22	145	18 x 4	15	6,82	8,12
02035 E	90	16	110	200	23	160	18 x 8	34	7,26	8,64
02036 E	110	16	133	220	24	180	18 x 8	22	9,89	11,77
• 02037 E	125	16	150	230	26	190	18 x 8	18	14,18	16,87
• 02038 E	140	16	167	250	28	210	18 x 8	16	16,14	19,21
• 02039 E	140 x 125	16	149	250	28	210	18 x 8	16	17,60	20,95
02040 E	160	10	190	285	31	240	22 x 8	12	19,50	23,21
• 02041 E	200	10	227	315	32	270	22 x 8	8	23,54	28,01
• 02042 E	225	10	250	340	32	295	22 x 8	5	26,78	31,87

PVC Festflansch mit Bundbuchse und Klebemuffe

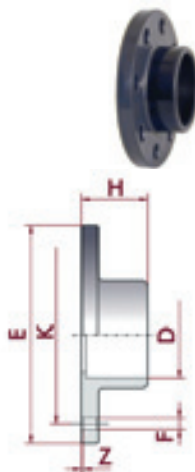

Artikel-Nr.	D	PN	H	Z	E	K	F	VPE	€ ohne MwSt.	€ inkl. MwSt.
• 22579 E	50	16	35	4	152	110	18 x 4	20	9,15	10,89
• 22580 E	63	15	42	4	165	125	18 x 4	12	11,37	13,53
• 02226 E	75	16	47	3	185	145	18 x 4	20	11,95	14,22
• 02227 E	90	16	56	5	200	160	18 x 8	15	13,81	16,43
• 02228 E	110	16	66	5	220	180	18 x 8	10	16,89	20,10
• 02229 E	125	16	74	5	230	190	18 x 8	16	21,13	25,14
• 02230 E	140	16	81	5	250	210	18 x 8	11	26,68	31,75
• 02231 E	160	10	91	5	285	240	22 x 8	8	36,31	43,21
• 02232 E	200	10	112	6	315	270	22 x 8	5	46,60	55,45
• 02233 E	225	10	125	6	340	295	22 x 8	3	55,38	65,90

Flachdichtung



Artikel-Nr.	D	d	E	H	K	F	VPE	€ ohne MwSt.	€ inkl. MwSt.
• 02061 E	50	50	71	3	110	18	160 (20)	0,98	1,17
02062 E	63	63	88	3	125	18	120 (20)	1,07	1,27
02063 E	75	75	104	3	145	18	100 (10)	1,42	1,69
02064 E	90	90	123	3	160	18	80 (20)	1,56	1,86
• 02065 E	110	110	148	4	180	18	60 (20)	1,98	2,36
• 02066 E	125	125	166	4	190	18	30 (10)	2,36	2,81
• 02067 E	140	140	186	4	210	18	60 (10)	2,63	3,13
02068 E	160	160	211	4	240	22	40	2,94	3,50
• 02069 E	200	200	245	5	270	22	30	3,72	4,43
• 02070 E	225	225	275	5	295	22	30	8,01	9,53

PVC Druckfittings / Ventile

PVC Flanschsatz mit Klebemuffen

Artikel-Nr.	D	PN	L	VPE	€ ohne MwSt.	€ inkl. MwSt.
• 02371 E	75	10	97	3	33,76	40,17
• 02372 E	90	10	115	2	45,27	53,87
• 02373 E	110	10	136	3	52,80	62,83
• 02374 E	125	10	152	3	62,00	73,78
• 02375 E	140	10	166	2	75,51	89,86
• 02376 E	160	6	186	2	107,21	127,58
• 02377 E	200	6	227	1	133,91	159,35
• 02378 E	225	6	255	1	156,59	186,34



PVC Schauglas mit Klebemuffen

Artikel-Nr.	D	L	H	E	VPE	€ ohne MwSt.	€ inkl. MwSt.
02387 E	50	31	130	80	12	17,28	20,56
02388 E	63	38	159	92	12	21,25	25,29

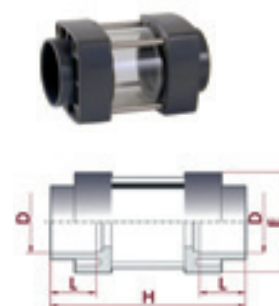

PVC Kugelhahn Serie STD mit Klebemuffen

Artikel-Nr.	D	PN	L	H	E	VPE	€ ohne MwSt.	€ inkl. MwSt.
36501 E	20	16	16	87	50	24 (12)	8,02	9,54
36502 E	25	16	19	101	61	10 (5)	8,82	10,50
36503 E	32	16	22	122	70	8	11,66	13,88
36504 E	40	16	26	135	81	6	13,51	16,08
36505 E	50	16	31	149	96	10	18,23	21,69
36506 E	63	16	38	174	118	10	24,82	29,54
36507 E	75	10	44	216	146	4 (1)	78,19	93,05
• 36508 E	90	10	51	256	176	1	113,67	135,27
• 36509 E	110	10	63	359	228	1	203,21	241,82



PVC Kugelhahn Serie STD mit Innengewinde

Artikel-Nr.	G	PN	L	H	E	VPE	€ ohne MwSt.	€ inkl. MwSt.
• 36511 E	1/2"	16	16	87	50	24 (12)	8,71	10,36
• 36512 E	3/4"	16	19	101	61	10 (5)	9,62	11,45
• 36513 E	1"	16	22	122	70	8	12,56	14,95
• 36514 E	1 1/4"	16	26	135	81	6	14,53	17,29
36515 E	1 1/2"	16	31	149	96	10	19,92	23,70
36516 E	2"	16	38	174	118	10	27,19	32,36
• 36517 E	2 1/2"	10	44	216	146	4 (1)	82,60	98,29
• 36518 E	3"	10	51	256	176	1	118,15	140,60
• 36519 E	4"	10	63	359	228	1	215,03	255,89

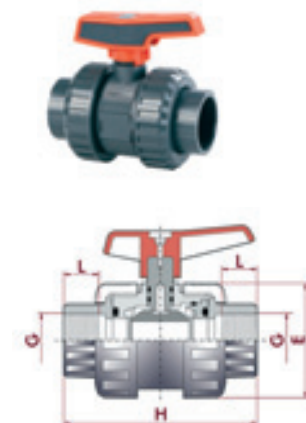

PVC Ventile



PVC-U Kugelhahn e-QUA Serie, mit Klebemuffen

Artikel-Nr.	D	PN	L	H	E	VPE	€ ohne MwSt.	€ inkl. MwSt.
• 41544 E	50	12	32,0	148,5	96	10	16,25	19,34
• 41545 E	63	12	38,5	174,0	118	10	23,54	28,01

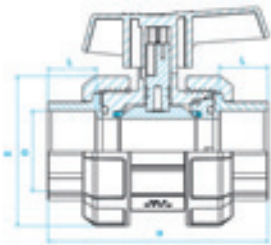

PVC-U Kugelhahn e-QUA Serie, mit Innengewinde

Artikel-Nr.	D	PN	L	H	E	VPE	€ ohne MwSt.	€ inkl. MwSt.
• 41546 E	1"	12	32,0	148,5	96	10	17,49	20,81
• 41547 E	2"	12	38,5	174,0	118	10	25,20	29,99



PVC-U Kugelhahn 3-Wege Serie

Artikel-Nr.	D	PN	VPE	€ ohne MwSt.	€ inkl. MwSt.
Klebemuffe					
• 20168 E	75	10	4	49,81	59,27
Innengewinde					
• 20170 E	90	10	4	52,75	62,77
Klebemuffe (ausrichtbar)					
• 20169 E	110	10	4	62,25	74,08



PVC-U Drehscheibenventil mit Klebemuffen

Artikel-Nr.	D	PN	VPE	€ ohne MwSt.	€ inkl. MwSt.
2-Wege					
• 16059 E	50-63	6	8	24,69	29,38
3-Wege					
• 15765 E	50-63	6	8	28,88	34,37
3-Wege					
• 41862 E	63-75	6	4	40,99	48,78



PVC Ventile

PVC-U Kugelhahn elektrisch betätigt - 2 Wege

Artikel-Nr.	D	PN	€	
			ohne MwSt.	inkl. MwSt.
12 - 48 Volt AC/DC				
• 29490 E	16	16	483,80	575,72
• 29491 E	20	16	483,80	575,72
• 29492 E	25	16	484,37	576,40
• 29493 E	32	16	488,96	581,86
• 29494 E	40	16	493,04	586,72
• 29495 E	50	16	537,91	640,11
• 29496 E	63	16	544,17	647,56
• 29497 E	75	10	853,62	1.015,81
80 - 240 Volt AC/DC				
• 31420 E	16	16	483,80	575,72
• 31421 E	20	16	483,80	575,72
• 31422 E	25	16	484,37	576,40
• 31423 E	32	16	488,96	581,86
• 31424 E	40	16	493,04	586,72
• 02628 E	50	16	537,91	640,11
• 02629 E	63	16	544,17	647,56
• 02630 E	75	10	853,62	1.015,81



i Auf Anfrage sind die elektrischen Kugelhähne auch in den Größen D 90 und D 110 lieferbar.

PVC-U Kugelhahn elektrisch betätigt - 2 Wege - Notbetätigung mittels Batteriepack

Artikel-Nr.	D	PN	€	
			ohne MwSt.	inkl. MwSt.
12 - 48 Volt AC/DC				
• 29500 E	16	16	1.040,18	1.237,81
• 29501 E	20	16	1.040,18	1.237,81
• 29502 E	25	16	1.040,74	1.238,48
• 29503 E	32	16	1.045,35	1.243,97
• 29504 E	40	16	1.049,43	1.248,82
• 29505 E	50	16	1.058,13	1.259,17
• 29506 E	63	16	1.064,42	1.266,66
• 29507 E	75	10	1.373,80	1.634,82
80 - 240 Volt AC/DC				
• 26417 E	16	16	1.040,18	1.237,81
• 05366 E	20	16	1.040,18	1.237,81
• 05367 E	25	16	1.040,74	1.238,48
• 05368 E	32	16	1.045,35	1.243,97
• 05369 E	40	16	1.049,43	1.248,82
• 05370 E	50	16	1.058,13	1.259,17
• 05371 E	63	16	1.064,42	1.266,66
• 05372 E	75	10	1.373,80	1.634,82



PVC-U Kugelhahn elektrisch betätigt - 3 Wege

Artikel-Nr.	D	PN	€	
			ohne MwSt.	inkl. MwSt.
elektrisch betätigt AC/DC				
12-48 V • 29870 E	50	16	561,61	668,32
80-240 V • 27227 E	50	16	561,61	668,32
elektrische Notbetätigung mittels Batterieblock AC/DC				
12-48 V • 29871 E	50	16	1.081,86	1.287,41
80-240 V • 27228 E	50	16	1.081,86	1.287,41

PVC Ventile

Absperrklappe



Artikel-Nr.	D	PN	VPE	€	
				ohne MwSt.	inkl. MwSt.
• 32614 E	63-75	10	2	80,75	96,09
• 32615 E	90	10	2	94,09	111,97
• 32616 E	110	10	2	104,49	124,34
• 32617 E	125-140	10	2	124,35	147,98
• 32618 E	160	10	2	152,10	181,00
• 32619 E	200-225	10	2	226,45	269,48

Absperrklappe pneumatisch betätigt - Aluminium-Antrieb



Artikel-Nr.	D	PN	€		
			ohne MwSt.	inkl. MwSt.	
doppelt wirkend					
• 30464 E	63-75	10	449,78	535,24	
• 30465 E	90	10	464,66	552,95	
• 30466 E	110	10	492,28	585,81	
• 30467 E	125-140	10	698,48	831,19	
• 30468 E	160	10	721,79	858,93	
• 30469 E	200-225	10	815,63	970,60	
• 30470 E	250-280	10	1.174,56	1.397,73	
• 32755 E	315	10	2.684,07	3.194,04	
einfach wirkend					
• 30471 E	63-75	10	620,74	738,68	
• 30472 E	90	10	744,32	885,74	
• 30473 E	110	10	771,96	918,63	
• 30474 E	125-140	10	1.193,84	1.420,67	
• 30475 E	160	10	1.217,16	1.448,42	
• 30476 E	200-225	10	1.310,97	1.560,05	
• 30477 E	250-280	10	1.529,50	1.820,11	
• 32757 E	315	10	5.623,77	6.692,29	

Absperrklappe pneumatisch betätigt - Antrieb & Ergänzungsbausatz*



Artikel-Nr.	D	PN	€		
			ohne MwSt.	inkl. MwSt.	
doppelt wirkend					
• 30478 E	63-75	10	799,99	951,99	
• 30479 E	90	10	814,89	969,72	
• 30480 E	110	10	842,52	1.002,60	
• 30481 E	125-140	10	1.048,70	1.247,95	
• 30482 E	160	10	1.072,02	1.275,70	
• 30483 E	200-225	10	1.165,84	1.387,35	
• 30484 E	250-280	10	1.524,80	1.814,51	
• 32756 E	315	10	3.157,59	3.757,53	
einfach wirkend					
• 30485 E	63-75	10	970,97	1.155,45	
• 30486 E	90	10	1.094,56	1.302,53	
• 30487 E	110	10	1.122,17	1.335,38	
• 30488 E	125-140	10	1.544,07	1.837,44	
• 30489 E	160	10	1.567,39	1.865,19	
• 30490 E	200-225	10	1.661,18	1.976,80	
• 30491 E	250-280	10	1.879,72	2.236,87	
• 32758 E	315	10	6.132,58	7.297,77	

*bestehend aus Magnetventil, Endschalterkasten und Druckreguliertventil

PVC Ventile

Absperrklappe elektrisch betätigt

Artikel-Nr.	D	PN	€ ohne MwSt.	€ inkl. MwSt.
12 - 48 Volt AC/DC				
• 30265 E	63-75	10	887,47	1.056,09
• 30266 E	90	10	902,87	1.074,42
• 30267 E	110	10	931,48	1.108,46
• 30268 E	125-140	10	1.665,10	1.981,46
• 30269 E	160	10	1.689,25	2.010,21
• 30270 E	200-225	10	1.969,29	2.343,45
• 30271 E	250-280	10	2.187,84	2.603,53
• 32741 E	315	10	3.986,54	4.743,98
80 - 240 Volt AC/DC				
• 30272 E	63-75	10	887,47	1.056,09
• 30273 E	90	10	902,87	1.074,42
• 30274 E	110	10	931,48	1.108,46
• 30275 E	125-140	10	1.665,10	1.981,47
• 30276 E	160	10	1.689,25	2.010,21
• 30277 E	200-225	10	1.969,29	2.343,46
• 30278 E	250-280	10	2.187,84	2.603,53
• 32742 E	315	10	3.986,54	4.743,98



Absperrklappe elektrisch betätigt - Notbetätigung mittels Batteriepack

Artikel-Nr.	D	PN	€ ohne MwSt.	€ inkl. MwSt.
12 - 48 Volt AC/DC				
• 30279 E	63-75	10	1.407,64	1.675,09
• 30280 E	90	10	1.423,07	1.693,45
• 30281 E	110	10	1.451,68	1.727,50
• 30282 E	125-140	10	2.276,86	2.709,46
• 30283 E	160	10	2.301,00	2.738,19
• 30284 E	200-225	10	2.577,35	3.067,05
• 30285 E	250-280	10	2.795,91	3.327,13
• 32743 E	315	10	4.909,24	5.842,00
80 - 240 Volt AC/DC				
• 30286 E	63-75	10	1.407,64	1.675,09
• 30287 E	90	10	1.423,07	1.693,45
• 30288 E	110	10	1.451,68	1.727,50
• 30289 E	125-140	10	2.276,86	2.709,46
• 30290 E	160	10	2.301,00	2.738,19
• 30291 E	200-225	10	2.577,35	3.067,05
• 30292 E	250-280	10	2.795,91	3.327,13
• 32744 E	315	10	4.909,24	5.842,00



PVC Ventile



Flanschsatz mit Bundbuchse und Losflansch (inkl. Schrauben, Muttern und Scheiben)

Artikel-Nr.	D	PN	VPE	€	
				ohne MwSt.	inkl. MwSt.
• 09119 E	63	10	3	25,74	30,63
• 09120 E	75	10	2	33,52	39,89
• 09121 E	90	10	3	51,41	61,18
• 09122 E	110	10	2	61,64	73,35
• 09123 E	125	10	2	78,66	93,61
• 09124 E	140	10	2	88,91	105,80
• 09125 E	160	6	2	138,02	164,24
• 09126 E	200	6	1	177,85	211,64
• 09127 E	225	6	1	201,38	239,64



Flanschsatz mit Festflansch (inkl. Schrauben, Muttern und Scheiben)

Artikel-Nr.	D	PN	VPE	€	
				ohne MwSt.	inkl. MwSt.
• 09128 E	75	10	2	33,29	39,62
• 09129 E	90	10	3	49,81	59,27
• 09130 E	110	10	2	58,22	69,28
• 09131 E	125	10	3	66,69	79,36
• 09132 E	140	10	2	78,70	93,65
• 09133 E	160	6	2	119,34	142,01
• 09134 E	200	6	1	149,20	177,55
• 09135 E	225	6	1	170,68	203,11



Rückschlagklappe

Artikel-Nr.	D	PN	A	B	C	VPE	€	
							ohne MwSt.	inkl. MwSt.
• 37055 E	63	10	109	20	32	15	24,56	29,23
• 08984 E	75	10	129	20	40	10	24,56	29,23
• 08985 E	90	10	144	20	52	8	28,30	33,68
• 08986 E	110	10	164	23	70	5	34,13	40,61
• 09040 E	125	10	170	25	83	5	39,92	47,50
• 08987 E	140	10	195	24	92	10	44,63	53,11
• 08988 E	160	6	220	26	112	5	48,59	57,82
• 09041 E	200	6	247	28	139	4	58,20	69,26

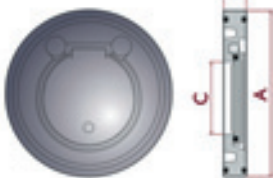

Rückschlagklappe mit Montagesatz

Artikel-Nr.	D	PN	C	H	E	VPE	€	
							ohne MwSt.	inkl. MwSt.
• 37073 E	63	10	32	20	109	2	50,32	59,88
• 23312 E	75	10	40	20	129	2	55,58	66,14
• 23313 E	90	10	52	20	144	3	73,60	87,58
• 23314 E	110	10	70	23	164	2	91,07	108,37
• 23315 E	125	10	83	25	170	2	112,45	133,82
• 23316 E	140	10	92	24	195	2	127,49	151,71
• 23317 E	160	6	112	26	220	2	170,55	202,95
• 23318 E	200	6	139	28	247	2	226,99	270,12

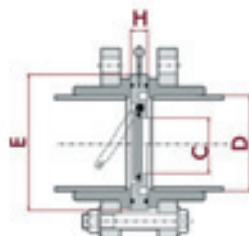

PVC Ventile

Kegelfussventil mit Klebemuffe

Artikel-Nr.	D	PN	L	H	E	VPE	€ ohne MwSt.	€ inkl. MwSt.
• 08994 E	40	16	26	176	84	6	14,73	17,53
• 08995 E	50	16	31	202	94	6	19,47	23,17
• 08996 E	63	16	38	239	117	4	27,07	32,21
• 08997 E	75	10	44	306	148	4 (2)	62,71	74,62

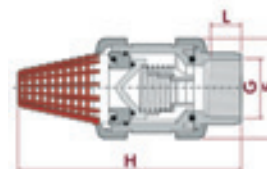

Kegelfussventil mit Innengewinde

Artikel-Nr.	G	PN	L	H	E	VPE	€ ohne MwSt.	€ inkl. MwSt.
• 09003 E	1"	16	22	154	70	10	13,11	15,60
• 09005 E	1½"	16	31	202	94	6	20,83	24,79
• 09006 E	2"	16	38	239	117	4	28,95	34,45
• 09007 E	2½"	10	44	306	148	4 (2)	66,12	78,68

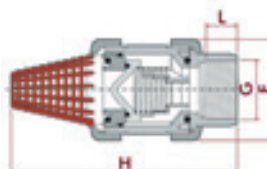

Kugelhahn PN10 mit PP Klemmverschraubung und Klebemuffe

Artikel-Nr.	D x D1	PN	L	L1	H	E	VPE	€ ohne MwSt.	€ inkl. MwSt.
• 02511 E	25 x 25	16	19	45	135	60	10 (5)	13,41	15,96
• 02512 E	32 x 32	16	22	53	157	71	8	17,55	20,88
• 02513 E	40 x 40	16	26	66	177	80	10	19,26	22,92
• 02514 E	50 x 50	16	31	67	190	90	6	23,41	27,86
• 02515 E	63 x 63	16	38	80	223	117	8	35,13	41,80
• 02516 E	75 x 75	10	44	95	283	148	4	103,35	122,99
• 34648 E	90 x 90	10	51	119	325	179	1	140,03	166,64
• 34649 E	110 x 110	10	61	149	355	179	1	164,60	195,87

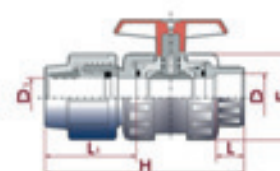

Kugelhahn PN10 mit PP Klemmverschraubung

Artikel-Nr.	D	PN	L	H	E	VPE	€ ohne MwSt.	€ inkl. MwSt.
• 02525 E	25 x 25	16	45	159	60	10	16,26	19,35
• 02526 E	32 x 32	16	53	193	74	5	20,35	24,22
• 02527 E	40 x 40	16	66	223	80	7	23,07	27,45
• 02528 E	50 x 50	16	67	229	90	5	30,21	35,95
• 02529 E	63 x 63	16	80	278	117	6	45,98	54,72
• 02530 E	75 x 75	10	95	334	148	3	110,77	131,82
• 34652 E	90 x 90	10	119	380	179	3	170,00	202,30
• 34653 E	110 x 110	10	149	434	179	2	199,25	237,11

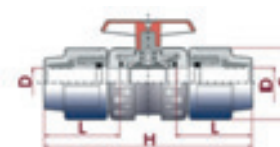

PP Klemmfittings für PVC Schlauch & PE Rohr

Winkel 90° mit Klemmanschlüssen



Artikel-Nr.	D	PN	L	Z	E	VPE	€ ohne MwSt.	€ inkl. MwSt.
• 01471 E	25 x 25	16	58	16	56	60 (10)	2,51	2,99
• 01472 E	32 x 32	16	81	18	65	30 (10)	3,10	3,69
• 01473 E	40 x 40	16	92	24	81	20	5,43	6,46
• 01474 E	50 x 50	16	108	28	92	25	7,59	9,03
• 01475 E	63 x 63	16	125	32	114	15	10,78	12,83
• 01476 E	75 x 75	10	140	37	128	8	18,05	21,48
• 17898 E	90 x 90	10	156	53	152	5	23,27	27,69
• 17899 E	110 x 110	10	176	63	182	3	48,29	57,47

T-Stück 90° mit 3 Klemmanschlüssen



Artikel-Nr.	D	PN	L	Z	E	VPE	€ ohne MwSt.	€ inkl. MwSt.
• 01508 E	25x25x25	16	58	16	56	40 (10)	3,56	4,24
• 01509 E	32x32x32	16	81	18	65	20 (5)	4,59	5,46
• 01510 E	40x40x40	16	92	24	81	12	7,59	9,03
• 01511 E	50x50x50	16	108	28	92	15	10,23	12,17
• 01512 E	63x63x63	16	125	32	114	8	15,17	18,05
• 01513 E	75x75x75	10	140	41	128	6	25,33	30,14

Muffe mit Klemmanschlüssen

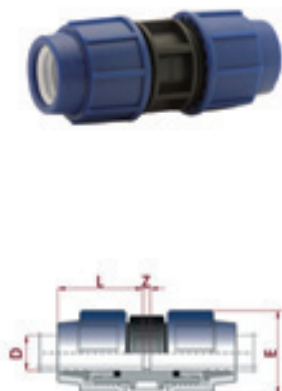

Artikel-Nr.	D	PN	L	Z	E	VPE	€ ohne MwSt.	€ inkl. MwSt.
• 01550 E	25 x 25	16	58	4	56	60 (10)	2,51	2,99
• 01551 E	32 x 32	16	81	4	65	40 (10)	3,19	3,80
• 01552 E	40 x 40	16	92	5	81	25	5,21	6,20
• 01553 E	50 x 50	16	108	8	92	30	7,01	8,34
• 01554 E	63 x 63	16	125	8	114	20	10,15	12,08
• 01555 E	75 x 75	10	140	10	128	12	18,24	21,71
• 17916 E	90 x 90	10	148	10	152	8	21,65	25,76
• 17917 E	110 x 110	10	167	12	182	4	46,13	54,89

i Fordern Sie unsere spezielle PVC/PP/PE Preisliste an.
Darin finden Sie das komplette Programm an Druckfittingsn,
Ventilen, Klappen etc..

FlexFit-Schlauch Fittings
Übergangverschraubung Klemmanschluss / Klebestutzen

Artikel-Nr.	D	PN	VPE	€ ohne MwSt.	€ inkl. MwSt.
• P71736 E	50	4	30	11,46	13,64
• P71905 E	63	4	25	26,84	31,94

Übergangverschraubung - Klemmanschluss / Klebemuffe

Artikel-Nr.	D	PN	VPE	€ ohne MwSt.	€ inkl. MwSt.
• P71737 E	50	4	24	11,46	13,64
• P71906 E	63	4	25	26,84	31,94

Übergangverschraubung - Klemmanschluss / Außengewinde

Artikel-Nr.	D	PN	VPE	€ ohne MwSt.	€ inkl. MwSt.
• P71739 E	50 x 1½"	4	25	12,97	15,43
• P71904 E	50 x 2"	4	24	14,00	16,66
• P71910 E	63 x 2"	4	36	27,87	33,17

Übergangverschraubung - Klemmanschluss / Innengewinde BSP

Artikel-Nr.	D	PN	VPE	€ ohne MwSt.	€ inkl. MwSt.
• P71740 E	50 x 1½"	4	24	18,82	22,39
• P71911 E	63 x 2"	4	25	30,07	35,78

Doppel-Verschraubung - Klemmanschluss / Klemmanschluss

Artikel-Nr.	D	PN	VPE	€ ohne MwSt.	€ inkl. MwSt.
• P71738 E	50	4	16	21,37	25,43
• P71907 E	63	4	18	55,75	66,35



FlexFit-Schlauch Fittings



Übergangswinkel 90° - Klemmanschluss / Klebemuffe

Artikel-Nr.	D	PN	VPE	€ ohne MwSt.	€ inkl. MwSt.
• P71741 E	50	4	25	13,78	16,40
• P71908 E	63	4	25	21,87	26,02



Übergangswinkel 90° - Klemmanschluss / Außengewinde

Artikel-Nr.	D	PN	VPE	€ ohne MwSt.	€ inkl. MwSt.
• P71903 E	50 x 1½"	4	25	13,76	16,38



Übergangswinkel 45° - Klemmanschluss / Klebemuffe

Artikel-Nr.	D	PN	VPE	€ ohne MwSt.	€ inkl. MwSt.
• P76497 E	50	4	25	15,33	18,24



Übergangswinkel 90° - Klemmanschluss / Klemmanschluss

Artikel-Nr.	D	PN	VPE	€ ohne MwSt.	€ inkl. MwSt.
• P71742 E	50	4	10	21,05	25,05
• P71909 E	63	4	10	52,64	62,65



Übergangs T-Stück 90° - Klemmanschluss / Klebemuffe

Artikel-Nr.	D	PN	VPE	€ ohne MwSt.	€ inkl. MwSt.
• P71743 E	50	4	18	15,61	18,58
• P71912 E	63	4	16	34,24	40,74

FlexFit-Schlauch Fittings / PVC Schlauch / PVC Rohr
Übergangs T-Stück 90° - Klemmanschluss / Klemmanschluss

Artikel-Nr.	D	PN	VPE	€ ohne MwSt.	€ inkl. MwSt.
• P71744 E	50	4	8	31,92	37,98
• P71913 E	63	4	10	75,22	89,51

FlexFit Montageschlüssel

Artikel-Nr.	D	PN	VPE	€ ohne MwSt.	€ inkl. MwSt.
• P71635 E	40	4	10	6,89	8,20
• P71634 E	50	4	10	8,31	9,89

PVC Schlauch*

Hergestellt aus PVC und ABS an der Innenseite, zum Verkleben an PVC Material mit PVC Kleber oder zur Verwendung in Klemmverschraubungen. Maximaler Betriebsdruck (Dauerbelastung): 2 bar.

Artikel-Nr.	D mm	Gewicht kg	Volumen m ³	VPE	€/m ohne MwSt.	€/m inkl. MwSt.
• 30755 E	25	6,0	0,08	25m	2,42	2,88
• 30756 E	32	9,6	0,07	25m	3,10	3,69
• 30757 E	40	12,3	0,11	25m	4,05	4,82
• 30758 E	50	18,4	0,15	25m	5,84	6,95
• 28575 E	63	27,0	0,24	25m	8,73	10,39
• 34588 E	75	33,3	0,30	25m	15,00	17,85
• P74043 E	90			25m	22,00	26,18



* Preis pro Meter. Nur in kompletten Rollen (à 25 m) lieferbar, kein Zuschnitt!
Auf Anfrage sind auch Rollen a 50 m lieferbar

PVC Rohr PN10 zum Verkleben*

Artikel-Nr.	D mm	Wandstärke mm	Stange m	VPE	€ ohne MwSt.	€ inkl. MwSt.
• 02708 E	40	1,9	5	6	1,61	1,92
• 02709 E	50	2,4	5	6	2,50	2,98
• 02710 E	63	3,0	5	6	3,86	4,59
• 02711 E	75	3,6	5	3	5,51	6,56
• 02712 E	90	4,3	5	3	7,93	9,44
• 02713 E	110	4,2	5	3	11,83	14,08
• 02714 E	125	4,8	5	3	15,14	18,02
• 02715 E	140	5,4	5	1	18,95	22,55
• 02716 E	160	6,2	5	1	24,80	29,51



* Preis pro Meter. Nur in kompletten Stangen (a 5 m) lieferbar, kein Zuschnitt!

PVC Rohr / Rohrklemmen



PVC Rohr PN16 zum Verkleben*

Artikel-Nr.	D mm	Wandstärke mm	Stange m	VPE	€ ohne MwSt.	€ inkl. MwSt.
• 02723 E	25	1,9	5	8	1,14	1,36
• 02724 E	32	2,4	5	8	1,82	2,17
• 02725 E	40	3,0	5	6	2,84	3,38
• 02726 E	50	3,7	5	6	4,32	5,14
• 02727 E	63	4,7	5	6	5,85	6,96
• 02728 E	75	4,6	5	3	8,23	9,79
• 02729 E	90	4,6	5	3	11,83	14,08
• 02730 E	110	6,6	5	3	17,68	21,04
• 02731 E	125	7,4	5	3	22,73	27,05
• 02732 E	140	8,3	5	1	28,41	33,81
• 02733 E	160	9,5	5	1	37,06	44,10

* Preis pro Meter. Nur in kompletten Stangen (a 5 m) lieferbar, kein Zuschnitt!

PP Rohrklemme ohne Bügel



Artikel-Nr.	D1	L	S	E	D2	M	VPE	€ ohne MwSt.	€ inkl. MwSt.
• 02136 F	50	84	16	49	68	51	150	1,03	1,23
• 02137 F	63	103	17	62	84	62	100	1,21	1,44
• 02138 F	75	129	20	75	107	75	80	1,61	1,92
• 02139 F	90	152	24	89	118	91	50	1,87	2,22
• 08908 F	110	161	24	107	143	90	35	3,62	4,30
• 08909 F	125	181	26	121	156	97	30	4,09	4,86
• 10955 F	140	201	28	195	176	113	15	4,38	5,21
• 08910 F	160	216	28	225	196	122	15	5,39	6,41
• 08911 F	200	256	31	265	243	142	10	6,58	7,84
• 10957 F	225	306	36	318	278	171	4	10,47	12,46

PP Rohrklemme mit Bügel



Artikel-Nr.	D1	L	S	E	D2	M	VPE	€ ohne MwSt.	€ inkl. MwSt.
• 02140 F	50	84	16	49	68	51	100	1,16	1,39
• 02141 F	63	103	17	62	84	62	50	1,31	1,56
• 02142 F	75	129	20	75	107	75	40	1,68	2,00
• 02143 F	90	152	24	89	118	91	25	1,99	2,36
• 08916 F	110	161	24	107	143	90	30	5,09	6,05
• 08917 F	125	181	26	121	156	97	25	5,73	6,82
• 10956 F	140	201	28	195	176	113	15	6,06	7,22
• 08918 F	160	216	28	225	196	122	10	7,05	8,39
• 08919 F	200	256	31	265	243	142	8	8,56	10,19
• 10958 F	225	306	36	318	278	171	4	12,32	14,67

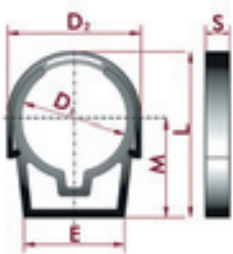

PVC Kleber & Reiniger

Cepex Reiniger

Artikel-Nr.	Bezeichnung	Gewicht kg	Volumen m ³	VPE	€ ohne MwSt.	€ inkl. MwSt.
02432 E	500 ml Dose	8,1	0,0260	15	7,14	8,50
02431 E	1 Liter Dose	11,0	0,0204	12	12,01	14,29



Cepex PVC Kleber ohne Pinsel

Artikel-Nr.	Bezeichnung	Gewicht kg	Volumen m ³	VPE	€ ohne MwSt.	€ inkl. MwSt.
02429 E	125 ml Tube	4,8	0,024	30	3,90	4,64
02427 E	500 ml Dose	8,0	0,026	15	10,27	12,22
02426 E	1 Liter Dose	13,0	0,036	12	18,62	22,16

Cepex PVC Kleber mit Pinsel

Artikel-Nr.	Bezeichnung	Gewicht kg	Volumen m ³	VPE	€ ohne MwSt.	€ inkl. MwSt.
02430 E	250 ml Dose, mit Pinsel	9,3	0,024	28	7,49	8,91
09043 E	500 ml Dose, mit Pinsel	8,9	0,024	15	12,94	15,40
09044 E	1 Liter Dose, mit Pinsel	12,8	0,024	12	22,02	26,20



UHU Kleber

Schnellhärtender, thixotroper PVC-U / Hart-PVC Klebstoff für das Kleben von Rohren, Muffen und Fittings mit kleinem und größerem Klebespalt (spaltfüllend) in Druck- und Abflusssystemen. In einem speziellen Kunststoffbehälter, der Dellen und Deformationen verhindert. Mit einer Spezialbürste für eine schnelle und einfache Verarbeitung. Geeignet für Durchmesser bis 315 mm, max. 16 bar (PN16). Erfüllt die europäischen Normen EN14814 und EN 14680. Technisches Datenblatt auf Anfrage.

Artikel-Nr.	Bezeichnung	Gewicht kg	Volumen m ³	VPE	€ ohne MwSt.	€ inkl. MwSt.
49015 E	500 ml Dose, mit Pinsel	8,1	0,024	12	28,00	33,32



i Neu im Programm!

Vorteile:

- Trocknet ca. 20-30 % schneller wie andere Klebstoffe, dadurch wird ein Drucktest schnell möglich.
- Pinsel als Bürste ausgeführt, optimale Verteilung des Klebstoffes an der Rohr Innen- und Aussenseite, da die Bürste sich perfekt an die Rundung anlegt. Die Bürste hat einen großen Griff, für einen guten Halt.
- Durch die Form der Bürste und die leichtere Handhabung wird deutlich weniger Klebstoff benötigt.
- Deckel mit Sicherheits- und Schnellverschluss. Mit einer 1/4 Drehung ist der Deckel sicher verschlossen.
- Kein zusätzlicher Anlöser notwendig.
- Kunststoffbehälter, keine Dellen oder Beulen am Behälter.
- Auf Wunsch stellen wir ein kostenloses Verkaufsdisplay zur Verfügung.

UHU Reiniger

Zur Reinigung und Entfettung von Rohren, Muffen und Fittings aus Hart-PVC, PVC-C und ABS. Kann auch zur Reinigung von Pinseln und Werkzeugen oder zur Entfernung von Kleberesten verwendet werden. Kein zusätzlicher Anlöser notwendig.

Artikel-Nr.	Bezeichnung	Gewicht kg	Volumen m ³	VPE	€ ohne MwSt.	€ inkl. MwSt.
49090 E	1 Liter Dose	12,8	0,036	6	24,99	29,74



PVC Kleber & Reiniger

Tangit Kleber



Artikel-Nr.	Bezeichnung	Gewicht kg	Volumen m ³	VPE	€ ohne MwSt.	€ inkl. MwSt.
02434 E	500 ml Dose	7,6	0,014	12	35,01	41,66
• 02433 E	1 Liter Dose	14,4	0,028	12	61,40	73,06

Kleber „Bondtite“ mit Pinsel



Kleber für PVC Schläuche und Rohre.

Artikel-Nr.	Bezeichnung	Gewicht kg	Volumen m ³	VPE	€ ohne MwSt.	€ inkl. MwSt.
27050 E	250 ml Dose	10,0	0,024	30	9,87	11,75
27051 E	500 ml Dose	8,10	0,024	15	14,68	17,47
• 27052 E	1 Liter Dose	12,8	0,036	12	23,80	28,32

Teflonband



Artikel-Nr.	Bezeichnung	Länge	VPE	€ ohne MwSt.	€ inkl. MwSt.
02435 E	Teflonband 12 mm	12	140 (10)	0,72	0,86
02436 E	Teflonband 19 mm	50	36 (6)	8,27	9,84

Montage-Hakenschlüssel für Rohre D20-D50



Artikel-Nr.	Bezeichnung	VPE	€ ohne MwSt.	€ inkl. MwSt.
23138 A	Montage-Hakenschlüssel	1	2,74	3,26

Ventilschächte

Runder Ventilschacht mit Schlauchventil

Artikel-Nr.	D	H	A	B	VPE	€ ohne MwSt.	€ inkl. MwSt.
• 17186 F	205	110	59	32	7(1)	27,86	33,16

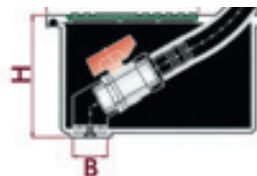

Runder Ventilschacht 5'', Deckel mit Clipbefestigung

Artikel-Nr.	D	H	A	B	C	D1	VPE	€ ohne MwSt.	€ inkl. MwSt.
• 02672 F	162	236	70	65	200	144	24 (1)	5,53	6,58

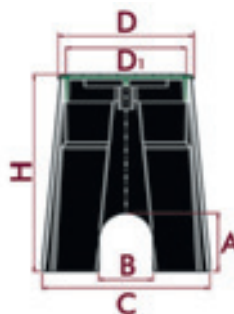

Runder Ventilschacht 9'', Deckel mit Clipbefestigung

Artikel-Nr.	D	H	A	B	C	D1	VPE	€ ohne MwSt.	€ inkl. MwSt.
• 02673 F	241	264	90	50	330	229	10 (1)	11,94	14,21

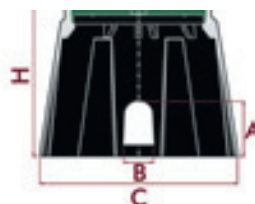

Ventilschächte



Rechteckiger Ventilschacht Standard, Deckel mit Schraubbefestigung

Artikel-Nr.	D	F	H	A	B	C	E	C1	C2	VPE	€ ohne MwSt.	€ inkl. MwSt.
• 02674 F	266	394	312	105	70	480	352	145	95	1	28,07	33,40

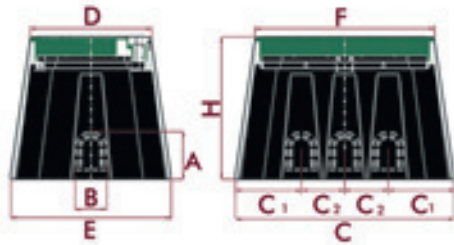

Rechteckiger Ventilschacht, Deckel mit Schraubbefestigung

Artikel-Nr.	D	F	H	A	B	C	E	C1	VPE	€ ohne MwSt.	€ inkl. MwSt.
• 02675 F	372	539	307	105	70	600	433	95	1	38,22	45,49

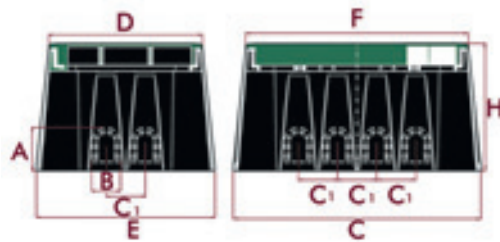

Frostschutzplatte

Artikel-Nr.	Für Ventilschacht	A	B	F	S1	S2	S	€ ohne MwSt.	€ inkl. MwSt.
• 31878 F	(02674)	95	359	231	22	48	70	2,19	2,61
• 31879 F	(02675)	90	316	477	35	46	81	5,61	6,68

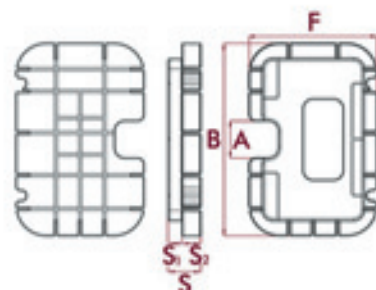



WWW.CEPEX.COM

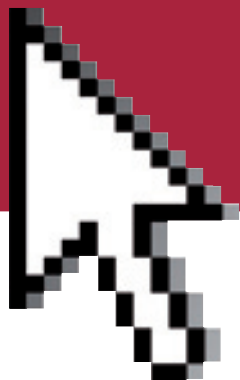

Technische Informationen
CAD 3D/2D Bibliothekszugang
Qualitäts-Zertifikate
Broschüren und Technisches Handbuch
Neuheiten
Pressemitteilungen
Vertriebsnetz

Technical information
Access to 3D/2D CAD Library
Quality certificates
Catalogs & brochures
New products
News
Sales network

WWW.CEPEX.COM